

AATON CAMERAS

LTR 16 mm camera
Instruction Manual
April 1984 . n° 99.013.01/01

AATON CINEMATOGRAPHIE
2, RUE DE LA PAIX - BP 104
38001 GRENOBLE Cedex . FRANCE
TELEPHONE (76) 42.64.09



Table of Contents

The Lens	1
Super 16	2
Viewing	3
Viewfinder	3
Viewing Screen	6
Mirror	7
Power	7
Batteries	8
Battery charger	8
PBX battery / video holder	9
Speed control	10
Atelen	12
Magazine	13
Feed	13
Take-up	15
Option L: Exposuremeter	16
Option T: Clear Time	20
Option R: Video Relay	21
Cleaning	25
Cold Weather Tips	27
Transport	28

The Lens

Adapting to Aäton

The lens holder of the Aäton camera is mounted directly onto the central chassis which carries the aperture plate. The flange focal distance of the Aäton is thus very stable and precise : 40 mm. The absolute accuracy of this tolerance is the most important factor contributing to image sharpness -- a strong point in the Aäton. Don't impair this feature with a poorly aligned lens or a mount which isn't perfectly clean.

When selecting a lens, or having it modified with an adaptor (Arri-, Eclair-, Nikon- to Aäton), be sure to obtain a flange focal distance of $40 \text{ mm} \pm 5 \text{ microns}$.

(A theoretical explanation of flange focal distance, as well as instructions for measurement, are contained in the technician's maintenance manual).

It is highly recommended to leave Aäton adaptors on lenses already fitted with other mounts (Arri, Nikon, etc.) ; even better is to remove the 'foreign' mount, and have an original Aäton lens mount fitted onto the neutral lens (e.g. Angenieux 9.5 - 57 mm or 10 - 150 mm, using parts numbered 101867 and 40733 (9.5 - 57), and 101867 and 40731 (10 - 150)).

Given the volume inside the camera body of a C-mount lens, this type of mount is incompatible with exposuremeter fitted Aätons -- the photocells are placed in the C-mount area. For use on an exposuremeter fitted camera, a C-mount lens should have the mount removed and replaced with an original Aäton mount.

Installation on the Camera

Turn the locking ring counter-clockwise as far as it can go, leaving room to insert the lens mount into the lens holder, with the three protruding lugs on the lens mount (or adaptor) corresponding to the slots in the locking ring. Tighten the locking ring by turning it clockwise. The lens is now in position.



lens fitted with adaptor



adaptor

Matte box

The Aäton LTR can be equipped with a lightweight rigid matte box : it has two 3" x 3" filter holders and one rotating mount. It fits on long handgrip rod, and accepts fixed focus and zoom lenses with front lenses up to 77 mm in diameter.

There is also a studio type bellows matte box available : this one has a bridge plate with two support rods and two 4"x 4" filter holders.

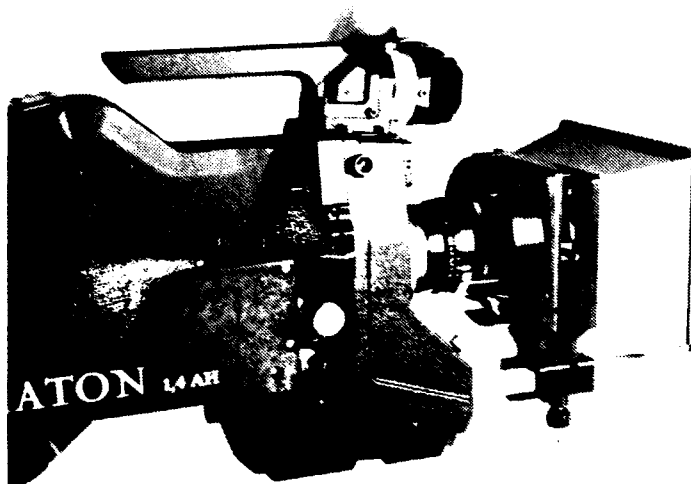

Super 16

The very high film steadiness and definition of the Aäton LTR camera make it an ideal choice for 35 mm blow up work. And to make the most of 16, the largest possible surface of the film has to be exploited -- this is where Super 16 comes in, using the otherwise unused sound track area on the unperforated side of the film. This gives a 47 % increase over standard 16 mm cropped to 1.66 ratio.

To cover this larger field (the diagonal is 14.5 as opposed to 12.7 mm), good lenses with higher coverage should be selected -- fixed focus distagons, or the Cooke Varo-Kinetal 10.4 - 52 zoom lens, specially designed for Super 16, for example.

More and more laboratories are equipped to handle Super 16. One very experienced laboratory providing reliable results is Du Art in New York. Numerous laboratories in Sweden have experience in Super 16 too; a great many of Sweden's feature films originate in Super 16 shot with Aäton cameras.

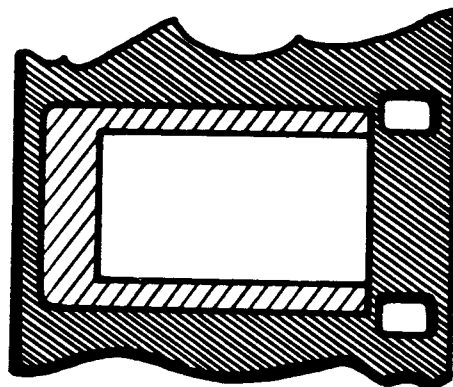

▨ added Super 16 area
(1:1.66 aspect ratio)

→ Have you read the American Cinematographer articles on Super 16?

March, September and October '83; April '84

You can, at a glance determine whether the lens holder is set up for standard 16 or Super 16:

If the lever is on the battery side of the camera, and moved upwards to fix the lens into place, then it is Super 16.

If the lens lock-in lever is on the motor side of the camera, and is moved downwards to tighten the lens into position, then the lens is centered for Standard 16.

To transform a camera set up for Super 16 to standard 16, the following operations must be carried out :

- the viewing screen must be shifted 1 mm;
- the viewfinder centering slot has to be put into position (see pic.). Like the lens lock-in lever, if it is on the battery side of the camera, centering is for Super 16; on the motor side, Standard 16.
- the lens port mount has to be set in relation to the aperture plate.

Conversion from Super 16 to standard 16 mm and vice versa is a workshop operation, and takes about thirty minutes.

Viewing

Viewfinder

The interchangeable viewfinder is a completely independent part of the camera and has a bayonet attached eyepiece; the entire viewfinder moves to allow shoulder/eye adjustment of the camera, and the eyepiece rotates over 360°. Automatic upright image.

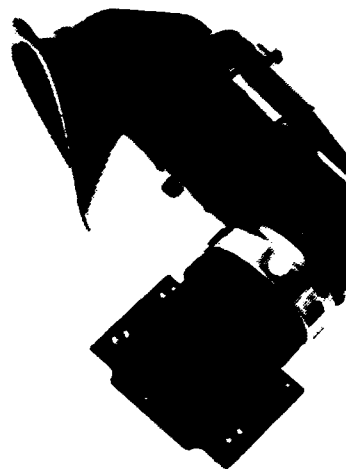
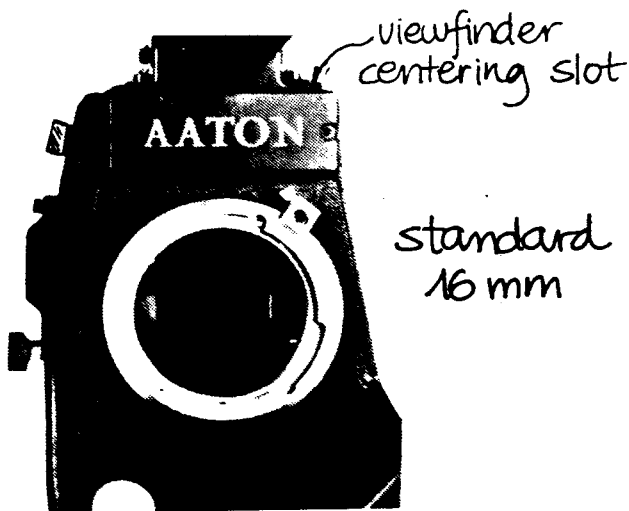

single position viewfinder

The interchangeable eyepiece for use on bayonet equipped viewfinders exists in three executions : left eye, right eye, and 20 cm long for tripod use.

The eyepiece shutter is actuated with a small knob above the rubber eyecup.

For manual upright image adjustment, a perfectly horizontal image can be obtained as follows : open both eyes, and fix them upon a vertical line (e.g. a window); align the two images by sliding the knob right of the eyepiece. The setting will be correct, whatever the initial position of the camera. In order to eliminate errors due to perspective, make this adjustment using a prime lens with a 50 mm focal length. The correct position is fixed into place by tightening the same knob.

An adjustment made by a given cameraman may not suit another, given that no two persons' left and right eyes are aligned in exactly the same way.

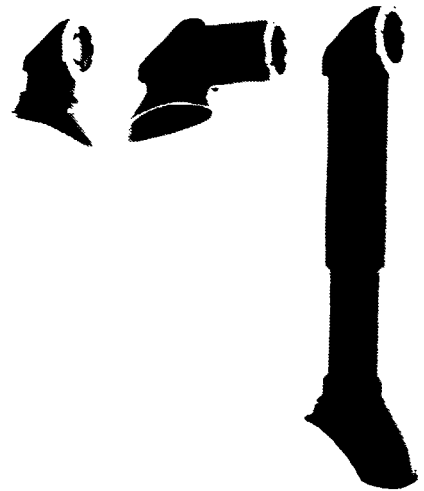

right, left, long eyepieces

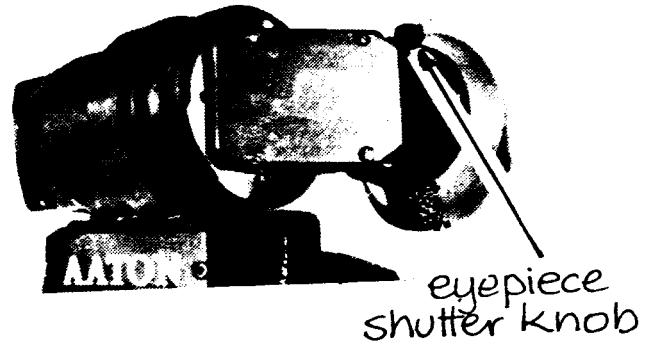

The dioptric setting is adjusted by turning the diopter ring on the viewfinder (see pic.) ; it can be set to ± 5 diopter, and is locked into position with the knurled screw fitted into it.

dioptric
setting

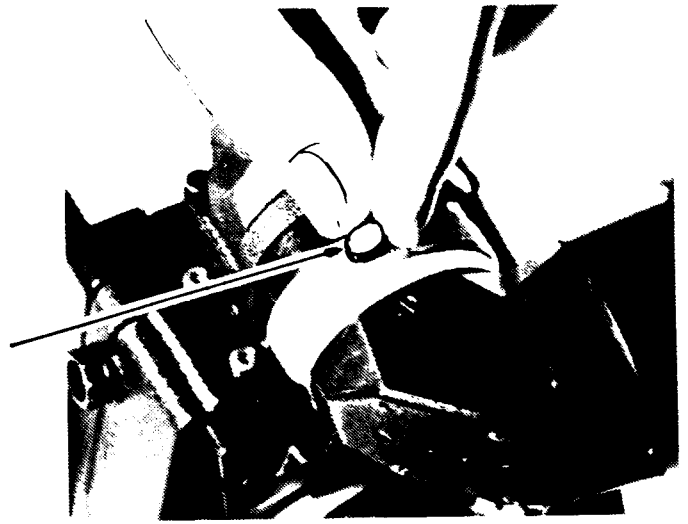

The eyepiece friction can be adjusted to individual preference as follows :

With an Allen wrench, loosen the locking screw (Hc 3 x 3) ; insert the Allen wrench into the opening at 90° away from the locking screw, and turn the friction ring until the desired friction is obtained. Then tighten the locking screw.

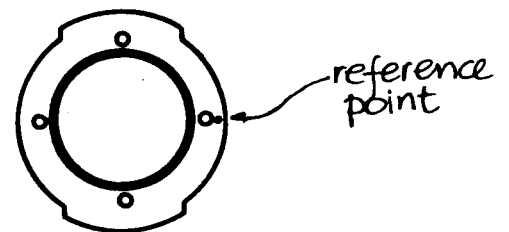

All three eyepieces are fitted with 4 openings allowing an "over-ride" of the automatic upright image in cases of unusual camera positions . Alongside one of the four holes there is a shallow bored reference point; when

the eyepiece positioning pin is fitted into this reference position, the image will automatically fall into upright position. You will note that for the long eyepiece, this means attaching it to the viewfinder in just the opposite of normal tripod viewing position.

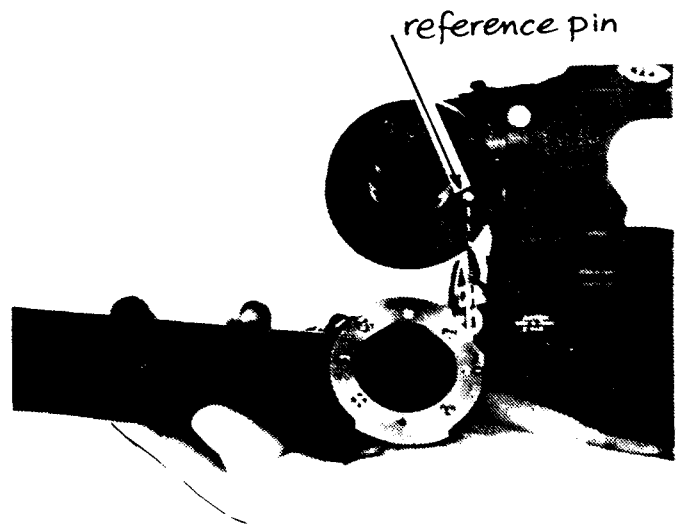
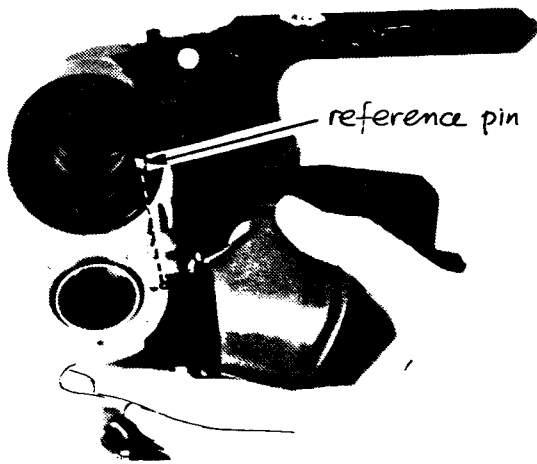

placing short and long eyepieces onto viewfinder

On adjustable viewfinders, the viewfinder angle relative to the camera body can be set:

Loosen the position lock screw on the upper handgrip (see pic.); set the eyepiece up or down to the chosen level; then tighten the screw.

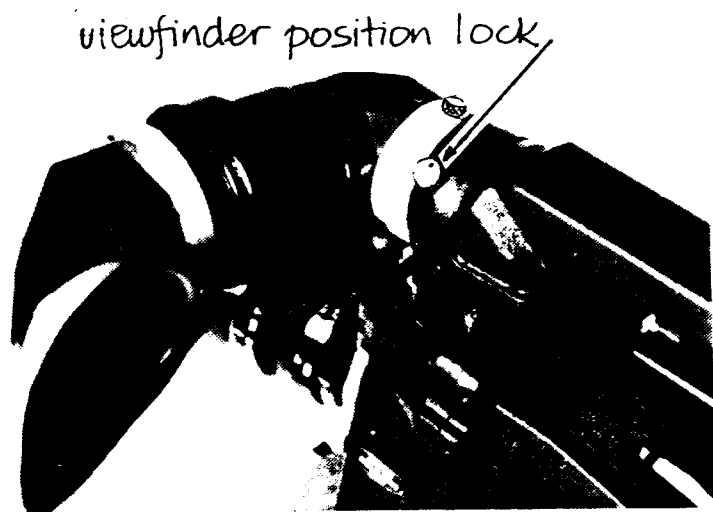

Viewing Screen

The viewing screen system in the Aaton LTR is of a special **patented design**. It consists of a concave fiber optic base, with a lens flush against it. This accounts for the extreme brightness and crispness of the image in the viewfinder.

The viewing area outside the frame is the largest offered by professional 16 mm cameras today.

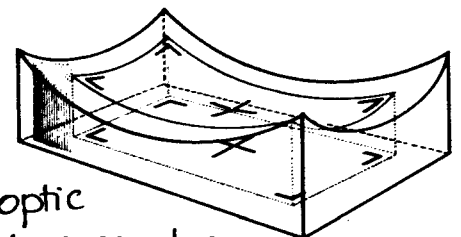

fiber optic viewing screen base

Mirror

The rotating mirror is very wide, maximising high speed shutter action; it opens at 180° for 50 cycle HMI lighting at 25 fps, and 60 cycle HMI lighting at 24 fps.

The mirror stops automatically in viewing position; it can be moved manually for gate inspection by actuating the inching knob on the motor. If the mirror has been inched out of viewing position, it is advisable to inch it back to viewing position before starting the motor up again; this avoids undue effort on the mirror gears. Always inch counter-clockwise (see pic.)

Cleaning: see p.25.

Exposuremeter

See Option L, p. 17.

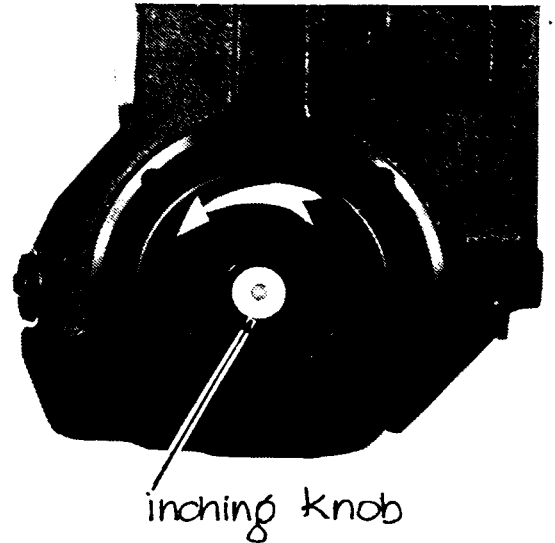

Power

The current consumption of the camera with a 12 volt (nominal) power supply is from .9 to 3.2 amps (at $+45^\circ$ and -20° C respectively). The voltage tolerance is from 10 to 16 V.

In case of power overload or polarity reversal (for example crossed wires when running the camera from an automobile battery) there is a fuse protection (Jahnichen 272005 - 5 amperes) on the PBX battery holder (see pic.).

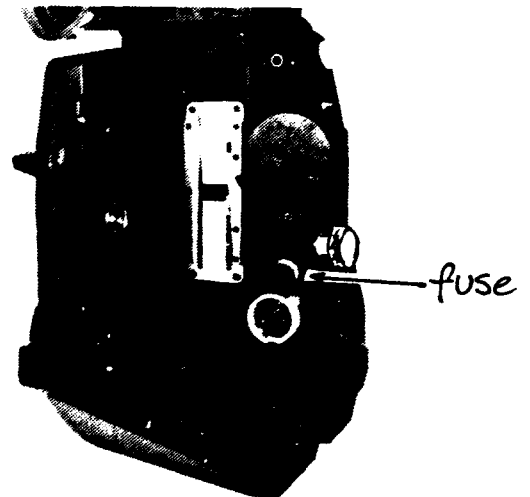

Batteries

The small clip-on Aäton battery (12 V 1.4 Ah, selected cells) drives an average of 5 magazines in normal weather conditions. In cold weather, it is advisable to keep the battery in a warm place (above 10°C -- a shirt or jacket pocket, for example) using the 54LL cable connected to the standard Cannon XLR 4.11 connector on the battery holder. (For further cold weather notes, see p. 27).

If the camera is not going to be used for a long period of time, it is advisable to remove the battery. After two weeks on board the camera, the battery would be discharged.

** for general remarks on battery chargers, see p. 29.*

Battery Charger

The T4 12 V 300m A battery charger shown here runs on either 110 or 220 V ; setting on knob on front of housing (yes, it's a tough one to turn!)

Then the charger is connected to mains and battery or batteries connected, either directly to the charger (1), or via B2 serial connection cable (2).

Full charge is obtained in 5 ½ hours. For each additional charge, the charger must be unplugged and reconnected to the mains.

If the mains current should for some reason be cut off , the charger will start a new 5 ½ hour charge when the power comes back on; Aäton batteries generally survive this treatment, though it is of course best to avoid it.

Fuse protection: mains 160 mA (T)
battery 400 mA (T)

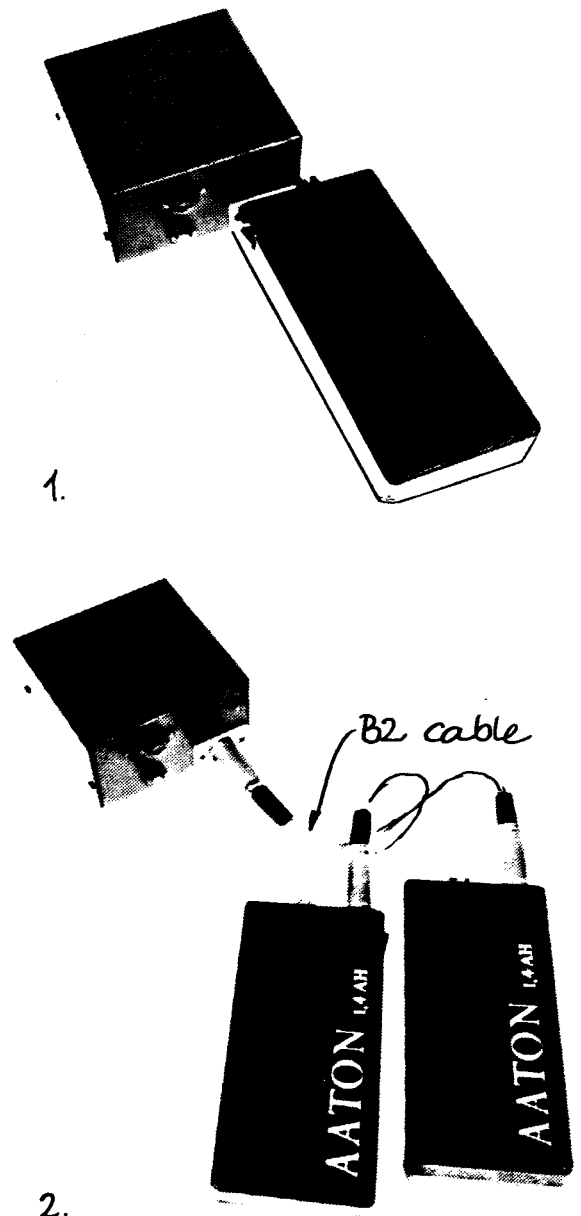

PBX battery/video holder

The PBX universal battery/video holder contains from the top downwards :

- **red diode** : warning signals ; the same red diode function appears in the viewfinder (see p.).
- **yellow diode** : lit to show when camera is running.
- **video camera holder** and cover for same : access via M3 hex screw (see option R, p.21).
- **Amphenol connector**, delivering electronic signals for remote on/off, TV sync, tachometry, etc...
- **standard XLR 4.42 connector** : pin attribution :
 - .1 : ground
 - .2
 - .3

 - .4 : + battery

- **Jaeger pin attribution** :
 - .1 : ground
 - .2 : TV sync
 - .3 : external signal from Atelen : 2400 Hz
 - 4 : + battery

The PBX is permanently fixed to the central chassis of the camera and should not need to be removed in normal maintenance.

There are two diodes on the PBX :

- red : warning signals ; the same red diode function appears in the viewfinder (see p.12)
- yellow : lit up when the camera is running.

The round opening on the PBX constitutes an accessory holder for VR 30 video camera (see option R, p. 21). During use without this accessory, this opening is plugged with a cover held into place using an M3 Allen screw.

Speed Control

The motor is driven by electronic circuits housed in the camera base, which is interchangeable on location.

Manual drive

The inching knob on the motor can be used to drive the camera manually for gate inspection. Push the thumb against the knob, and turn counter-clockwise. It is advisable to inch the mirror back to viewing position before starting the motor; however not doing so will not harm the motor.

Start up

Actuate one of the two on/off switches: one on the front body housing, the other on the front handgrip. Both switches provide three positions:

- single shot/ test position
- off
- on

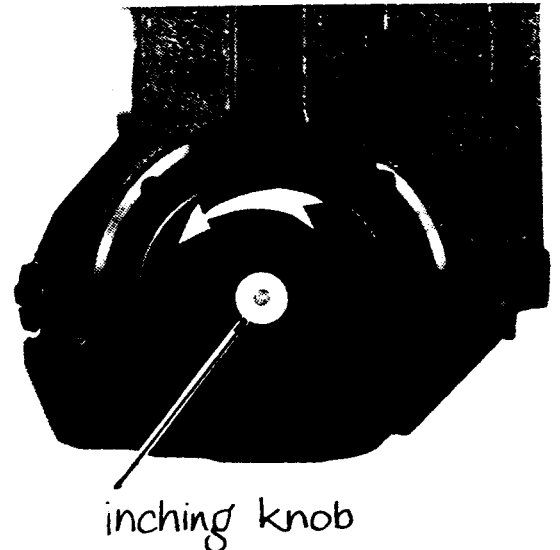

Crystal speed

To avoid unfortunate mishaps, it is advisable to check the camera speed before using a camera for the first time. As well as the variable speeds (see below), the camera has two crystal speeds: 24 or 25 fps (precision: $\pm 1/4$ frame over 10 minutes, i.e. 1 magazine).

To obtain crystal speed:

- Set the speed knob to the white dot located between 20 and 28 fps.
- Set the 24 / 25 fps switch to desired speed.

Variable speed

Variable speeds of 6, 12, 16, 18, 20, 28 and 32 are obtained by adjusting the speed knob to the desired setting.

Single shot

Single shot is obtained by putting the switch in the test position.

Maximum rate is 1 fps; exposure: 1/4 s

The Lemo plug on the front housing can be used for connection with an intervalometer.

Speed control diodes

When the camera is running, whatever the set speed, the external yellow diode is lit.

The external red diode and the red diode in the viewfinder have the following functions :

- lit: the camera is running at the set variable speed.

- out: the camera is running at the set crystal speed.
- slow flicker (1/2 Hz): the battery is low (below 10.5 V), but sync is not lost.
- fast flicker (2 Hz): the camera is not running at the set speed.

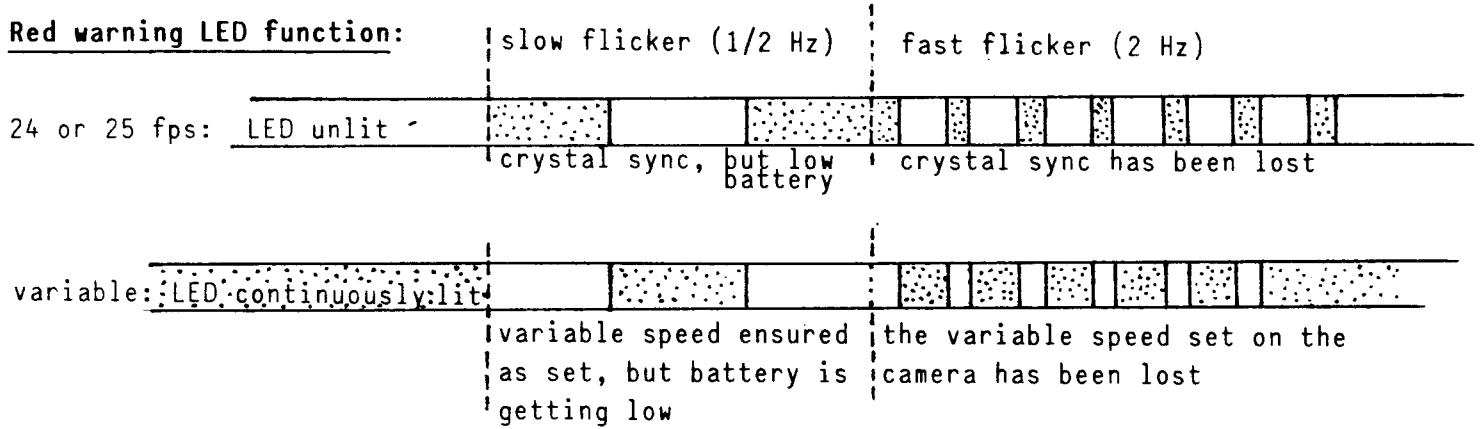

Atelen

The Atelen accessory delivers an external master frequency derived from a video signal, or pilotone, to the camera. This allows automatic elimination of the TV bar, and of flicker generated by HMI lights. This accessory functions at 50 cycles only connection to camera on PBX (on XLR or Amphenol connectors)

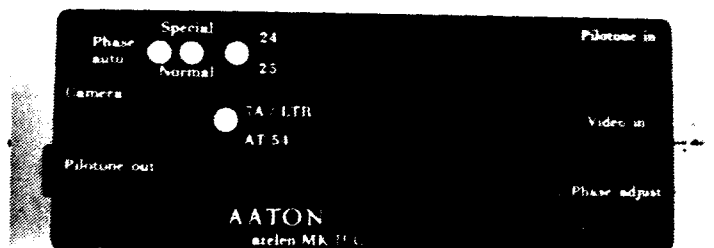

7 x 18 cm.

Magazine

The coaxial magazine takes 120 m (400 ft) double or mono perforation 16 mm stock on 50 mm cores.

Before putting a magazine on the camera, it is always advisable to make sure the aperture plate is clean, and the lateral film pressure bar moves freely.

The magazine is extremely **easy to load**. Many Aäton users have discovered that they no longer need three magazines to allow their assistant to keep up with loading: two are enough.

Good news for those shooting in cold climes: threading is so simple that you can do it with gloves on!

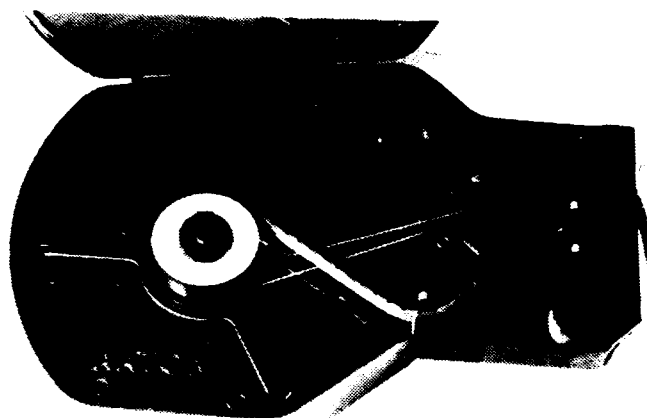

Feed

Loading feed compartment

Block the footage counter by turning the indicator counter-clockwise.
Unfasten lid lock by turning it downwards.
Open lid (which is fixed onto the magazine for ease of handling in the changing bag).
Squeeze the core-lock mechanism inwards with thumb and forefinger on either side.
Place the roll of film over the core holder, and press on the center to lock the core into place.

Thread 10 cm of film into the left/right passage, and ensure that the film passes outside the idler roller.

Lock the lid, making sure the film is not caught in so doing.

Unblock the footage counter by turning it clockwise.

The indications correspond to film on a 50 mm core.

For 30 m. daylight reels:

- To remove the core holder, loosen screw 02.613.02 with knurled screw in place near left/right passage; use knurled screw to hold bobbin on spindle.

Lift the core holder; place the 30 m. reel on spindle.

When re-installing the core holder, tighten screw 02.613.02 with the knurled screw ; check that the head of the small screw (02.613.02) does not protrude.

The knurled screw can then be put back into place.

Take-up

Threading the take-up compartment

These steps do not have to be done in the changing bag

Open both pinch rollers by pressing the aluminium release buttons.

Pull through the film which appears in the left/right passage slot.

Introduce the end of the film into the upper film guide, passing below the first idler roller; it will appear outside the magazine nose.

Re-introduce the film into the lower film guide, and pull through about 15" of film.

Thread the film around the upper sprocket wheel, making sure the perforations engage with the sprockets.

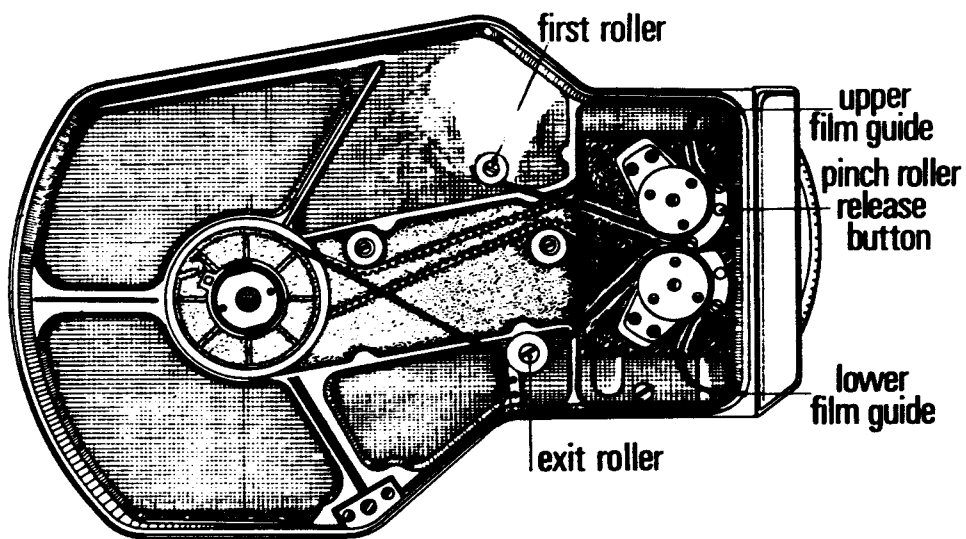
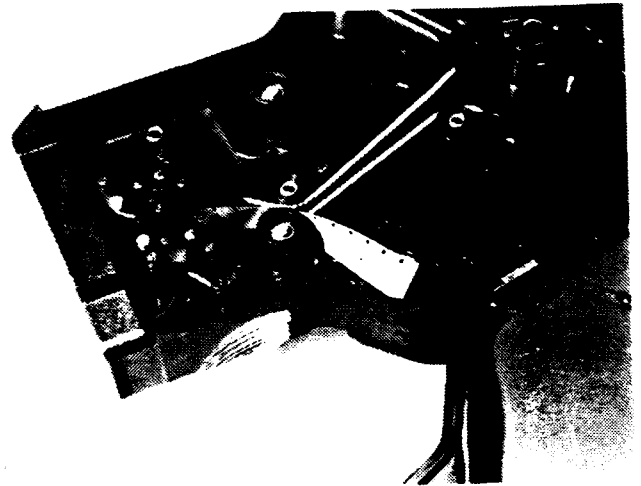

Push the pinch roller back into position **without pressing the aluminium release button** ; when the pinch roller is in the correct position, you will hear a noticeable click.

Thread the film around the lower sprocket wheel so as to obtain a taut length of 15 frames outside the magazine nose. Then push the pinch roller back into position (again, without pressing on the aluminium release button).

Fit the film end into the core, and wind on a few thicknesses of film.

With the film from the core taut, and guided below the exit roller, place the core onto the take-up spindle and lock it into position by pressing down on the central button. You will note the positioning pin on the spindle which maintains the core securely.

Any slack film between the left/right passage and the upper sprocket wheel can be taken up by winding the take up spool. The film coming out of the left/right passage should be guided below the upper roller.

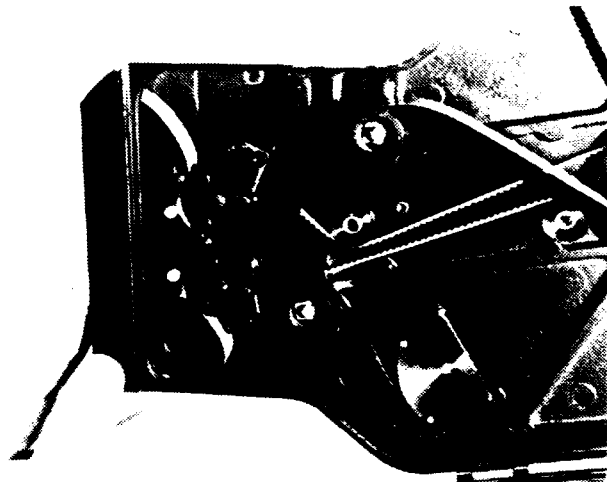

Putting the magazine on the camera

Holding the magazine by the back, rest it on the magazine brace; slide the magazine into the camera body.

When it is in place, a noticeable click indicates that the magazine lugs are held by the lock mechanism, and that the drive clutch has engaged into the drive dog.

Changing magazines

Hold the camera with left hand, push the magazine lock lever

Holding the magazine with the right hand, pull it backwards.

The aperture plate is now visible, and should be carefully cleaned if necessary.

Option L: Exposuremeter

Two photocells measure the quantity of light reflected by the film during the entire exposure time, thus giving a measurement independent of fps.

In test position, one frame is exposed for $1/4$ of a second; the measurement is corrected to give an indication usable at 24 or 25 fps crystal speed.

The film sensitivity from 50 to 400 ASA is set on a ten position switch.

A luminous micro-diode display well above the frame-line in the viewfinder leaves a large visible zone outside the frame. The reading is shown by a single darkened diode moving over a line of green and yellow LEDs.

Each LED represents a third of a stop:

- the central green LED indicates the position of normal exposure for the film sensitivity set on the camera.
- underexposure is shown when the darkened diode is towards the left (to minus 2 stops); overexposure is shown when the diode is to the right (to plus 2 stops).

These readings are made looking through the viewfinder in normal use.

When the light level is too low, the green LED on the left is out ; when the light level is too high, the green LED on the right is out. Underexposure or overexposure are thus shown even when the darkened diode has gone off the display.

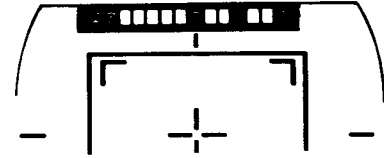

Fine adjustments

If a discrepancy is observed between the camera display and an independent photometer, it is advisable to double-check before adjusting the camera photometer.

To ensure correlation between the camera photometer and an independent photometer known as a reference to the cameraman, the following operations should be carried out:

1. With the 'reference' exposuremeter, measure the incident light; note the suggested T stop.
2. Set the camera lens to the T stop indicated by the reference exposuremeter.
3. Run the camera with film, and look through the viewfinder at an 18% standard grey surface. The darkened diode is ideally in the central position, indicating that the exposure is correct.
4. If the darkened diode is not in the center position, it is possible to adjust the camera's photometer system to correlate precisely with the reference exposuremeter:
 - a. remove the front photometer circuit cover on the body.
 - b. with a screwdriver, turn the sensitivity potentiometer (see pic.) until the darkened diode is in the center position (i.e. the central green diode is darkened).

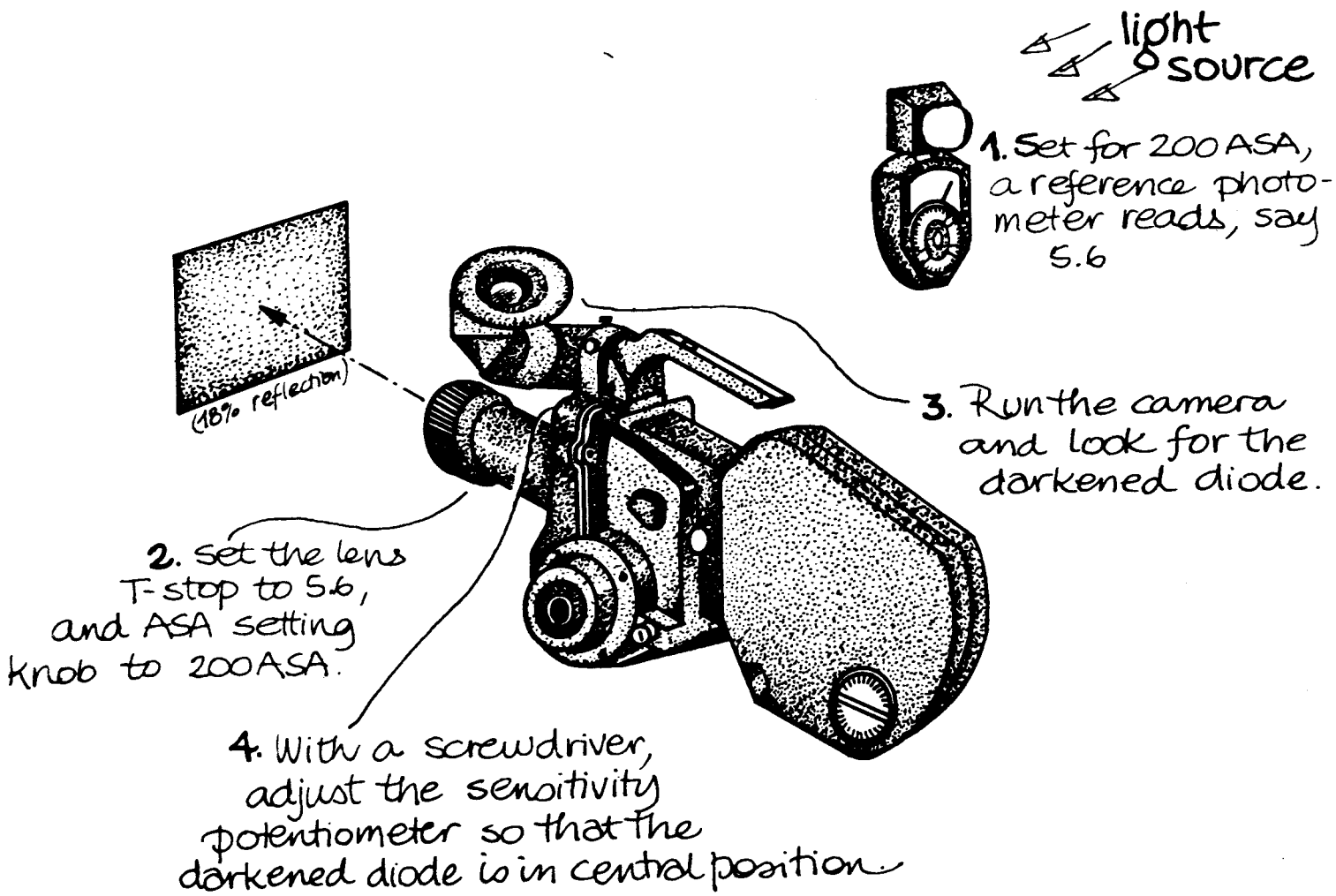

light source



1. Set for 200 ASA, a reference photometer reads, say 5.6

3. Run the camera and look for the darkened diode.

2. set the lens T-stop to 5.6, and ASA setting knob to 200 ASA.

4. With a screwdriver, adjust the sensitivity potentiometer so that the darkened diode is in central position.

Option T: Clear Time Recording

For Clear Time Recording on 16 mm film; the Aäton LTR is equipped with Option T. This is the actual marking system inside the camera itself: microprocessor circuitry, and fiber optic device to expose clear figures onto the edge of the film each second as it moves over the gate.

An initializer is used to set camera and sound recorder to local or conventional time. This is small hand calculator sized device called Orign C.

A small microprocessor cicuit is installed on the sound recorder ; it provides SMPTE time information which is recorded directly onto the tape, leaving the pilotone signal completely intact.

Option R: Video relay

Option R consists of two optical subassemblies fitted into the camera body: a beam splitter which bleeds off 50% of the light going from the viewing screen to the viewfinder, towards a relay lens and mirror providing an aerial image of the viewing screen at the rear of the central chassis.

To put the R option to work, a small tubular video camera (Aäton VR30) is fitted into the PBX battery/video holder, transforming the aerial image into an electronic signal to be monitored or recorded for later viewing.

The beam splitter is retractable; when the video signal is not being used, the cameraman can remove the beam splitter from the light path, leaving all the light for the viewfinder image. To retract the beam splitter:

- unscrew the button on the side of the camera body (see pic.)
- with an m3 Allen wrench in this opening, turn clockwise (about 30 turns) until you feel a resistance indicating the pellicle is out of the light path.
- to slide it back into video viewing position, turn the screw counterclockwise until it locks; then 2 turns clockwise to bring the beam splitter into the correct position.

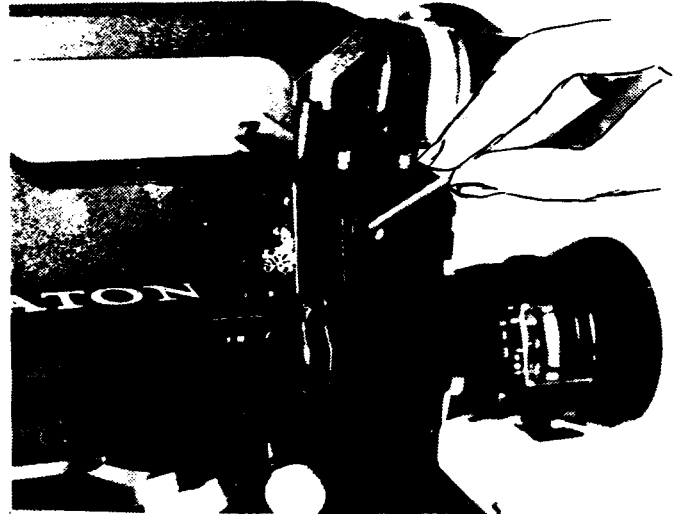

positioning the retractable beam splitter.

To insert the VR30 video camera, loosen the small M3 locking screw on the side of the PBX.

Remove the plug



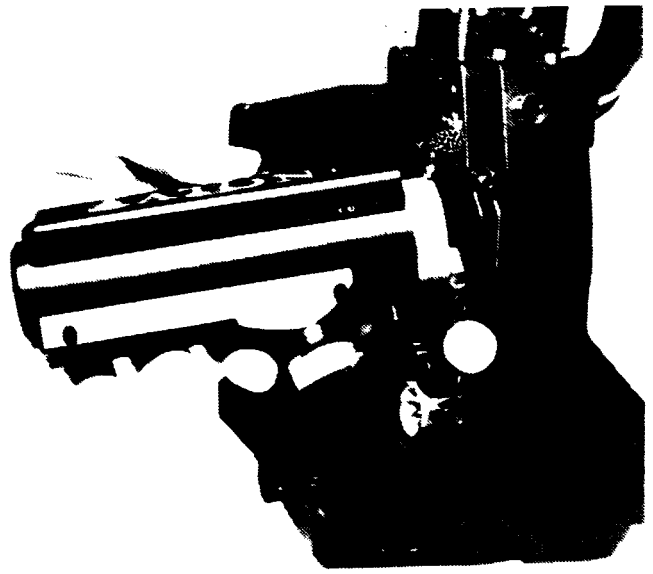

Now insert the VR30 camera into the opening so that the protruding Amphenol plug goes into the guiding socket; push firmly so that the VR30 is in contact with the gold colored reference surface inside the opening.

Tighten the locking screw with the M3 Allen wrench; there is no need to screw it in too tightly .

With the SPX cable, connect the VR30 camera and the control unit. The power supply (ideally a 4 Ah battery) is connected to either the PBX or the control unit using a 54LL cable on the XLR Cannon socket. Only one power supply need be used for both the film camera and the video camera (if 2 batteries are used in parallel on the two XLR plugs, this will cause high currents, and the batteries will discharge into each other, and burn out the SPX cable).

If using a VR30 camera for the first time on a given PBX, it is advisable to check the focus beforehand.

During the following steps, it may be helpful to push the "contour" potentiometer on the control unit to its maximum power; this enhances apparent sharpness thus making it easier to find the best focus adjustment at the expense of the aesthetic quality of the picture.

- Turn the power on and wait five minutes or so for the camera to warm up and reach its level of performance.
- With a screwdriver in the "focus" opening on the control unit, check on a TV monitor that the optimum focus current is being sent to the VR30 camera.
- Insert a screwdriver into the setting screw at the rear of the VR30 housing (see pic.); turning this screw moves the actual video tube horizontally so that the target can be placed in the exact position of the aerial image obtained from the viewing screen. Again, use the monitor to determine optimal position; when the image can be made no sharper, check the electronic focus once more, and you are ready to go.

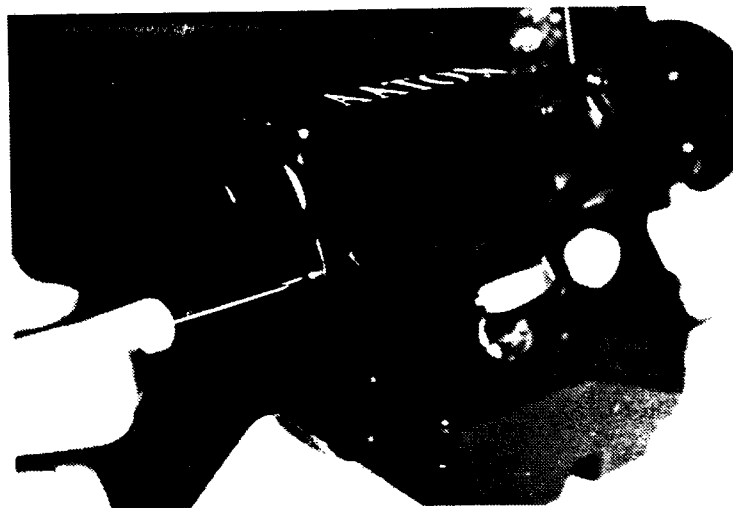

focussing, the video tube

On the control unit, select the video standard to be used: 25 fps, 30 fps, or 24 fps.

Standards

In 50 cycle IV countries, if monitoring or recording a film camera running at 25 fps, the obvious choice is 50 Hz 625 lines.

If monitoring only, and the camera running at 24 fps, select 48 Hz and 651 lines; this minimizes flicker and improves resolution on any monitor.

If recording only, and film camera running at 24 fps, select 50 Hz 625 lines to be compatible with standard recorders; alternative solution better for flicker reduction and definition, shift the VTR field frequency to 48 Hz, and the video viewing system to 48 Hz 651 lines.

In 60 cycle TV countries with all cameras running at 24 fps, if monitoring only, select 48 Hz 651 lines ensuring minimum flicker and optimal resolution on a professional monitor. If recording, choose 60 Hz 525 lines, which is the VTR standard in these countries.

Other settings

If you are not familiar with video electronics don't modify the horizontal, vertical, and black level settings on the control unit.

If you are familiar with video electronics...
 Black level setting: with no light entering the camera, rotate the potentiometer to lift the black level just above the clamping level as seen on an oscilloscope or on the KWA 52 miniature professional monitor made by Aäton.
 Frame and sweep amplitude: use and underscanned monitor, and overscan the tube target to see the external diameter of the tube entering the four corners of the picture equally as seen on the monitor. When you return to normal scan, the round corners will not appear on the usable area of the monitor.

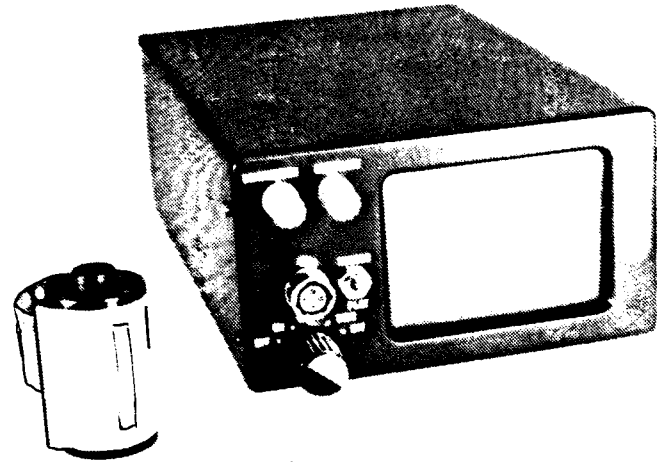

KWA monitor

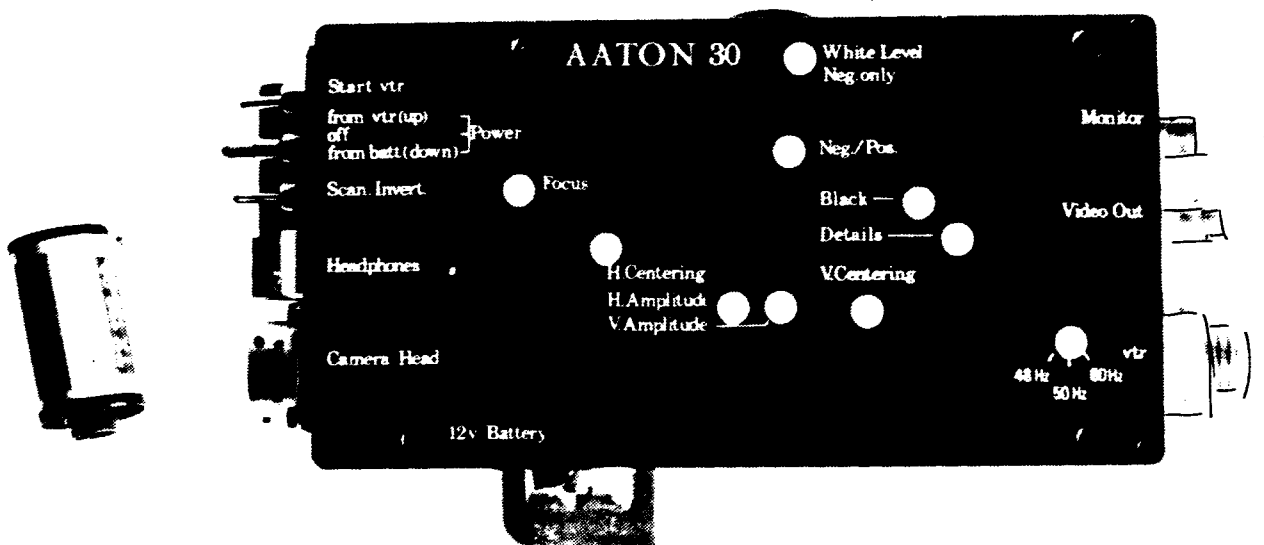

CTU 10/20 video control unit

Cleaning

Lens holder

It is of utmost importance, particularly when using wide angle and super speed zooms, to keep the front surface of the lens holder completely clean, as a build-up here can adversely affect the critical back focus needed to obtain the best results from such lenses.

Similarly, the rear surfaces of the lens mount itself must be regularly inspected and cleaned.

Viewfinder

The eyepiece glass should of course be cleaned on a regular basis; the whole eyepiece shutter and rubber must be removed from this if desired. A good quality lens cleaning fluid can be used if the lens becomes very greasy.

Mirror

Surface dust and dirt may be removed from the mirror from the front of the camera without removing the housing. For this, use the soft side of a lens cloth or good quality lens tissue wrapped around a cotton bud stick. It is not recommended to use lens cleaning fluid for this operation, as it will tend to smear too much due to uneven pressure.

If very thorough cleaning is required, the camera housing should be removed allowing freer and more even access to the mirror.

Viewing Screen

Here too, surface dust and dirt can be wiped or blown off. A plain clean cotton wool bud passed over the surfaces with light pressure is the best technique.

(On pre-LTR camera, the access to the top surface of the viewing screen is quite tight, and when using a cotton bud it is necessary to squeeze the plastic stick with pliers)

More thorough cleaning will necessitate the removal of the camera housing and possibly of the fibre screen itself, a workshop operation.

IMPORTANT NOTE : Be very careful when using "Dust-off" type air cannisters, not to use them off-level -- a burst of liquid or frozen freon can have disastrous effects on optical surfaces.

Aperture Plate

This should be kept very clean and free of grease by polishing with a good quality non-fluffy cloth (eg. the hard side of a lens cloth such as Selvyt, or good Egyptian cotton).

It is a good idea between magazines to give a quick brush over the aperture plate with a 10 mm paintbrush.

A sharpened wooden or plastic stick can be used to dislodge any emulsion build-up on the side guides.

A dust-off type air blower may be found useful in the cleaning operations here.

Care should be taken when cleaning the aperture itself so as not to dislodge any of the matte black paint.

N.B. Never remove the fixed guide rail on the left of the aperture plate (01.120.01), as it is set in the factory.

The areas around the aperture plate and chassis should be inspected and cleaned with a cloth, a 10 mm paint brush, and an air blower.

Magazines

Both take-up and feed sides of the magazine should be regularly cleaned by using a 10 mm paint brush to remove all traces of dust and dirt. In addition, the area around the sprocket wheels should be kept free of oil and grease.

The feed guide rails and pressure plates should be inspected and cleaned periodically: pressurized air cannisters or good rubber blowers can be utilized for this operation.

N.B. It will be found useful to keep the inside of the changing bag as clean as possible by turning it inside out and shaking it vigorously, paying particular attention to the corners.

Cold Weather Tips

(From Rune Ericson, based on his experience in filming in Greenland)

The Aaton on-board battery should be used in preference to battery belts which are exposed to the cold. Several small batteries can be warmed up much more easily than one large heavy one. Each member of the shooting can keep one in his or her breast pocket. When actually running film, the cameraman should have the Aäton battery in his breast pocket a lead to the camera: this will give him two or three four hundred foot rolls per battery.

- At 30° below zero (centigrade), Rune advises to wear lots of clothes in the sleeping bag, and to sleep with the batteries too.

- When filming out of doors in extreme cold, the camera should not be taken indoors at all, so as to avoid condensation inside and outside the camera. In any case, the camera should not be stored above 0° centigrade. If the camera **must** be taken inside, then it should be put in a hermetically sealed container. It should be allowed to thaw for a few hours before being removed from the sealed container.

- The raw stock should also be kept below zero: again, to avoid condensation. For the same reason, the magazine should also be loaded in the cold.

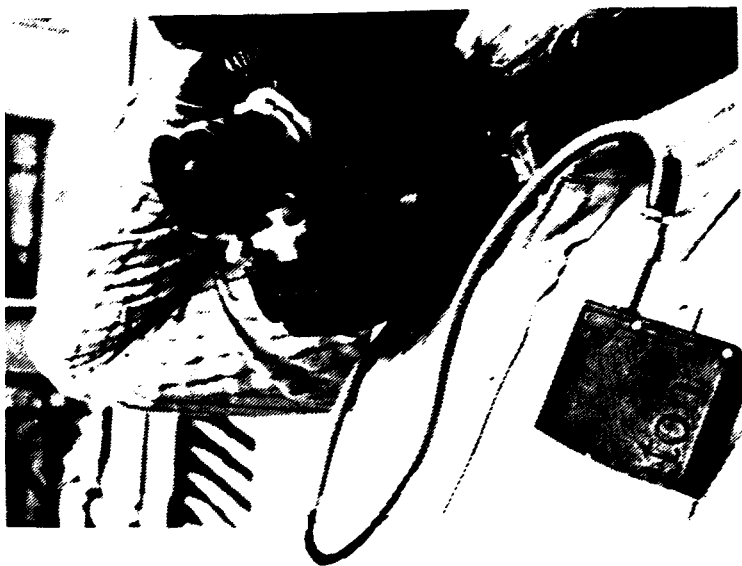

Transport

ALWAYS, ALWAYS, ALWAYS, ALWAYS, always remove the lens from the camera body during transport. Recently, an expert in endurance and vibration testing for bridges, freighters, etc... was asked to estimate the force that would be exerted on a lens mount if the camera, packed in its ruggedized metallic case with foam rubber inner housing, was dropped on the floor from about half a meter above. Said Aäton camera, equipped with a zoom lens 185 cms long weighing 1.38 kg. The answer was fantastic : at impact point, the camera was exposed to 100 g, which in other words is about 138 kilos. The pressure on the lens mount is

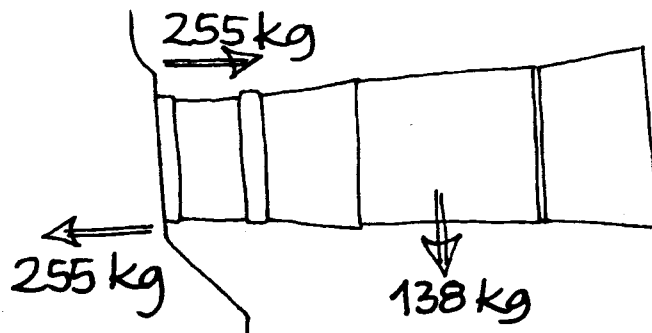

So just let your mind boggle a few minutes while you think about airport handling. Even hours of bumping along bad roads with the camera in the back of the vehicle can cause damage.

"Incidents" of this nature do not always cause obvious breakdowns in the camera ; the lens mount may simply feel a little ^{off} kilter, or the locking device sluggish. The lens itself often has no damage either. But where the problem is observed critically, is during projection - the back focal distance goes to blazes. In the factory, the camera is set to back focal distance precision down to the thousandth of a millimeter. The variation caused by a fall as described above is in the area of 4 to 5 hundredths of a millimeter : this is enormous, and destroy the necessary precision for the clean crisp images that have made a name for Aäton over the years.

